

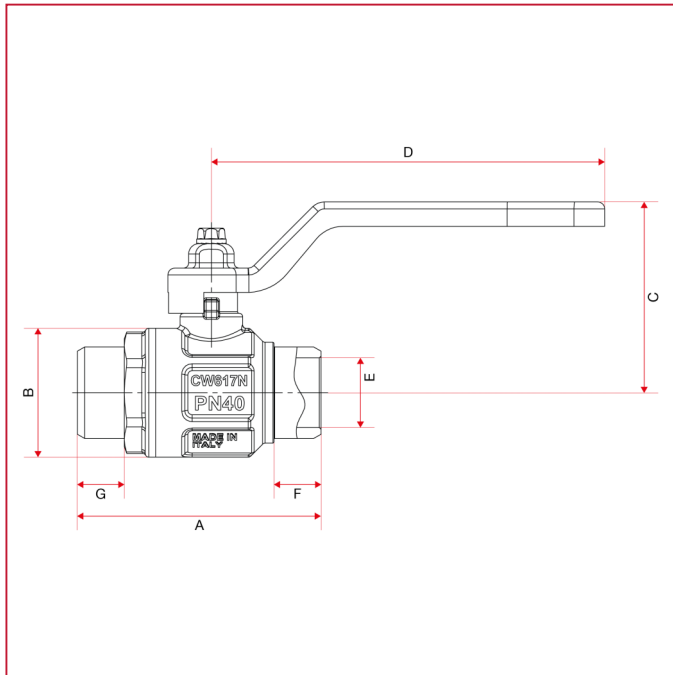

# KUGELHÄHNE IDEAL, VOLLER DURCHGANG

**099** Kugelhahn Ideal, voller Durchgang, Außengewinde/Außengewinde

## GESAMTABMESSUNGEN



	1/2"	3/4"	1"	1"1/4	1"1/2	2"
DN	15	20	25	32	40	50
A	59,75	70	77,5	91,5	106	120,5
B	30,5	37	45,5	57	70	84
C	41	55	59	75	81	96
D	80	113	113	138	138	157,8
E	15	20	25	32	39	50
F	11,5	13,5	14,5	17	19	21
G	11,5	13,5	14,5	17	19	21
Kg/cm <sup>2</sup> bar	50	40	40	30	30	25
LBS - psi	725	580	580	435	435	362,5