

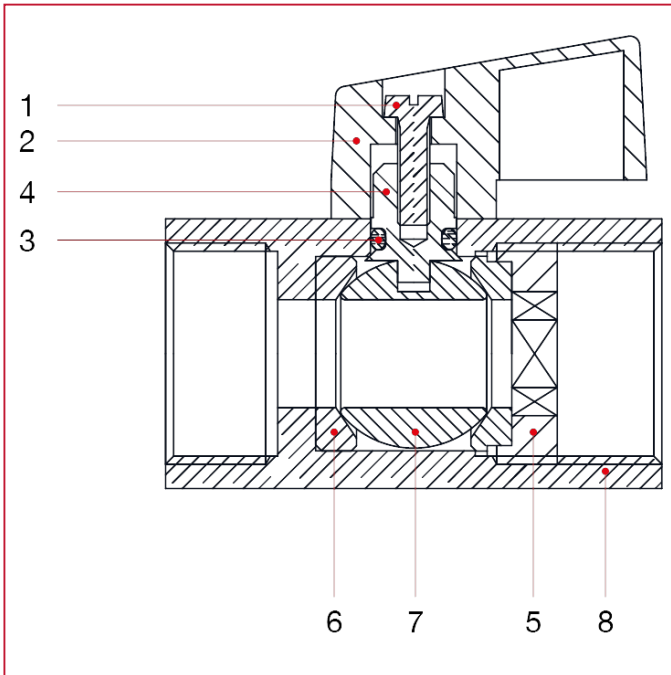

VÁLVULAS MINI

125 Válvula de esfera Mini

MATERIALES



POS.	DESCRIPCIÓN	N.	MATERIAL
1	Tornillo	1	Acero galvanizado Fe
2	Mando palanca	1	Polímero
3	Junta	1	NBR
4	Varilla	1	Latón CW617N
5	Manguito	1	Latón CW617N
6	Alojamiento	2	P.T.F.E.
7	Esfera	1	Latón cromado CW617N
8	Cuerpo	1	Latón cromado CW617N