

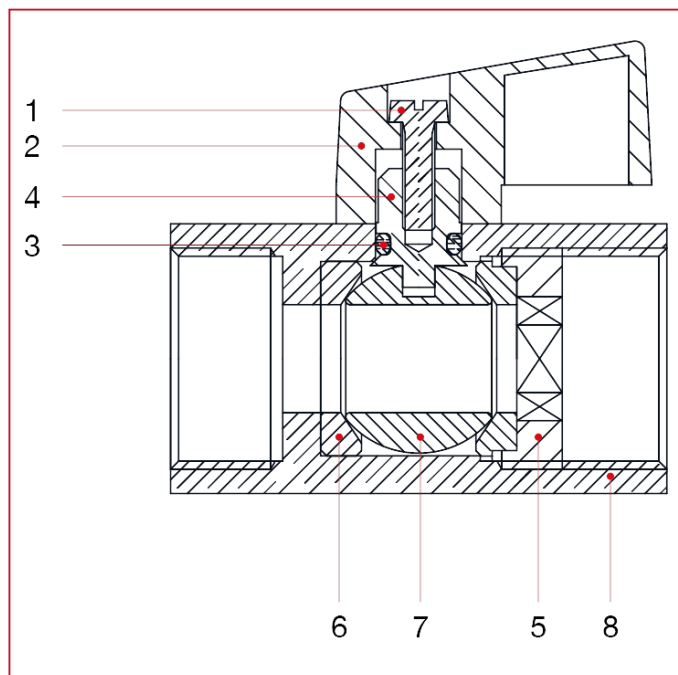

VALVOLE MINI

125 Valvola a sfera MINI

MATERIALI



POS.	DESCRIZIONE	N.	MATERIALE
1	Vite	1	Acciaio zincato Fe
2	Maniglia a leva	1	Polimero
3	Guarnizione	1	NBR
4	Asta	1	Ottone CW617N
5	Manicotto	1	Ottone CW617N
6	Sede	2	P.T.F.E.
7	Sfera	1	Ottone cromato CW617N
8	Corpo	1	Ottone cromato CW617N