

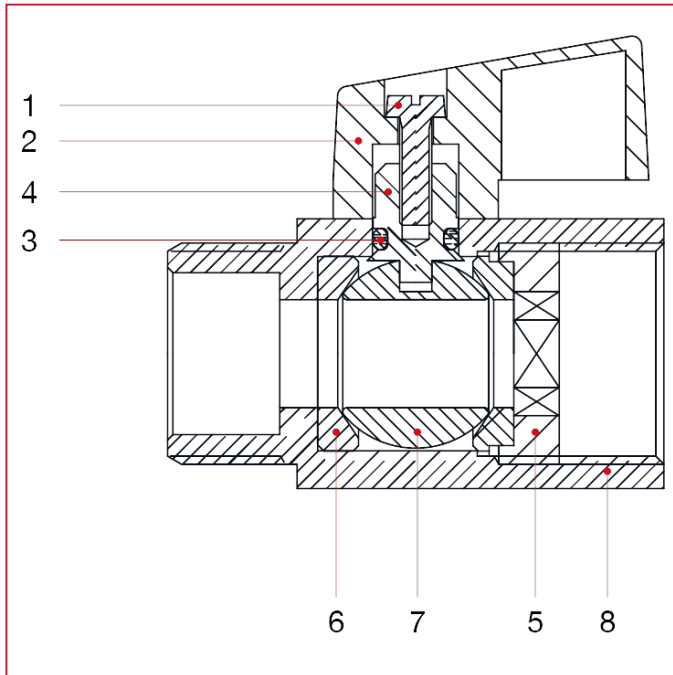

MINI BALL VALVES

126N Mini ball valves

MATERIALS



POS.	DESCRIPTION	N.	MATERIAL
1	Screw	1	Zinc-plated steel Fe
2	Lever handle	1	Polymer
3	Washer	1	NBR
4	Stem	1	Brass CW617N
5	End adapter	1	Brass CW617N
6	Seat	2	P.T.F.E.
7	Ball	1	Chrome-plated brass CW617N
8	Body	1	Chrome-plated brass CW617N