

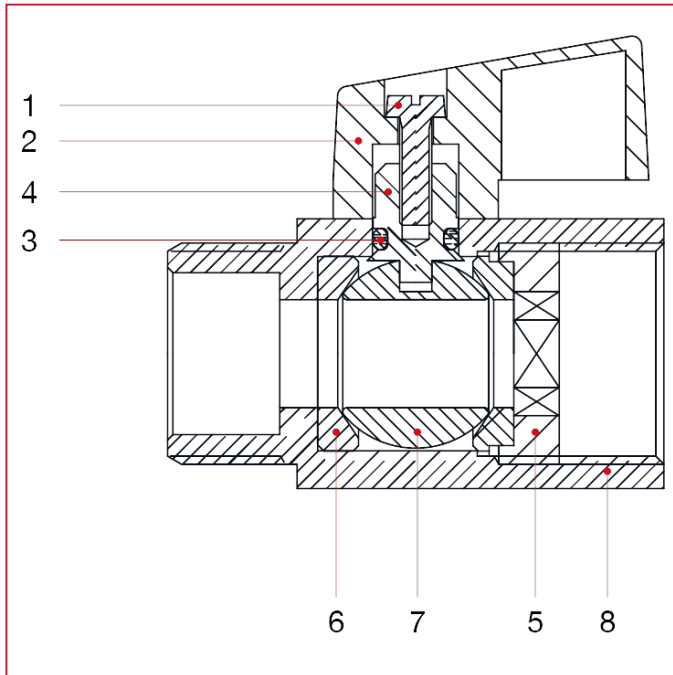

KUGELHÄHNE MINI

126 Kugelhahn Mini

WERKSTOFFE



POS.	BESCHREIBUNG	N.	MATERIAL
1	Schraube	1	Verzinkter Stahl Fe
2	Hebelgriff	1	Polymer
3	Dichtung	1	NBR
4	Spindel	1	Messing CW617N
5	Muffe	1	Messing CW617N
6	Sitz	2	P.T.F.E.
7	Kugel	1	Verchromtes Messing CW617N
8	Gehäuse	1	Verchromtes Messing CW617N