

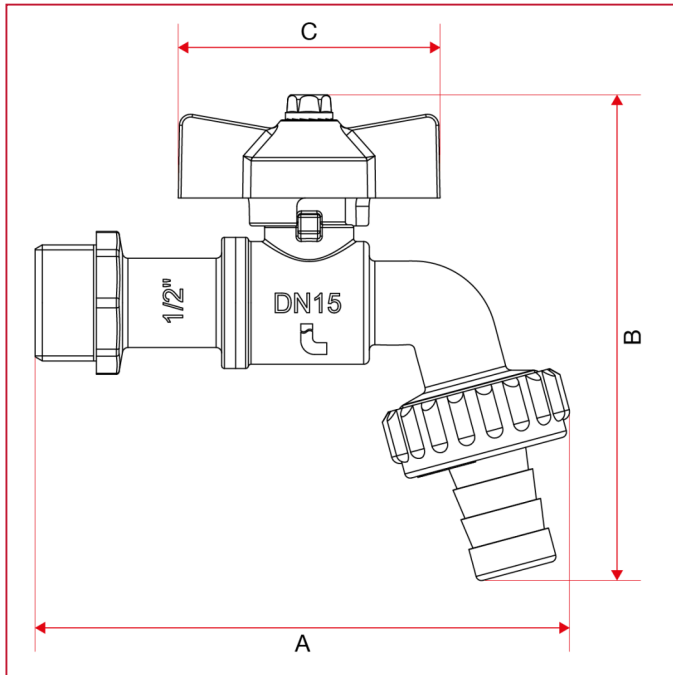

弯嘴龙头

176 可连接软管的 GAR 球阀弯嘴龙头

总尺寸



	1/2"	3/4"
DN	15	20
A	96	105,5
B	87	98
C	47	47
Kg/cm ² bar	15	15
LBS - psi	217,5	217,5