

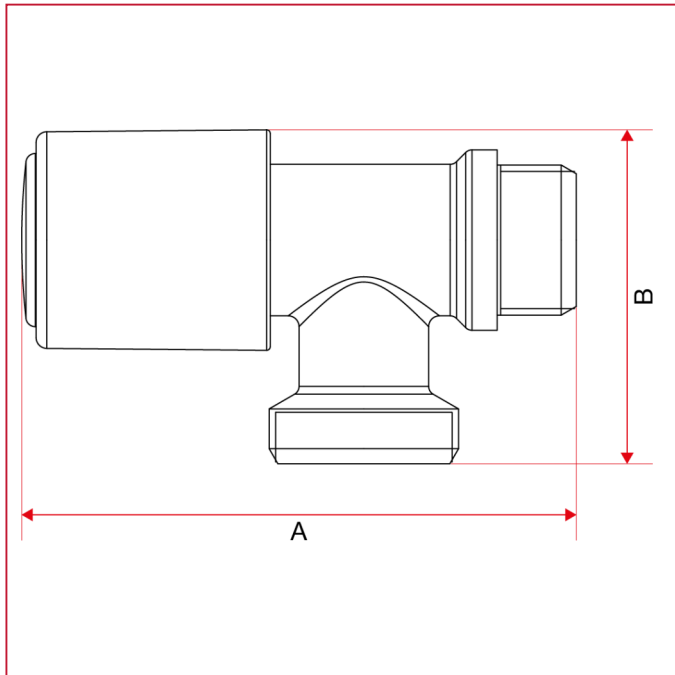

洗衣机用水龙头

226 水平洗衣机用水龙头

总尺寸



	1/2"
DN	15
A	77
B	46,3
Kg/cm ² bar	16
LBS - psi	232