

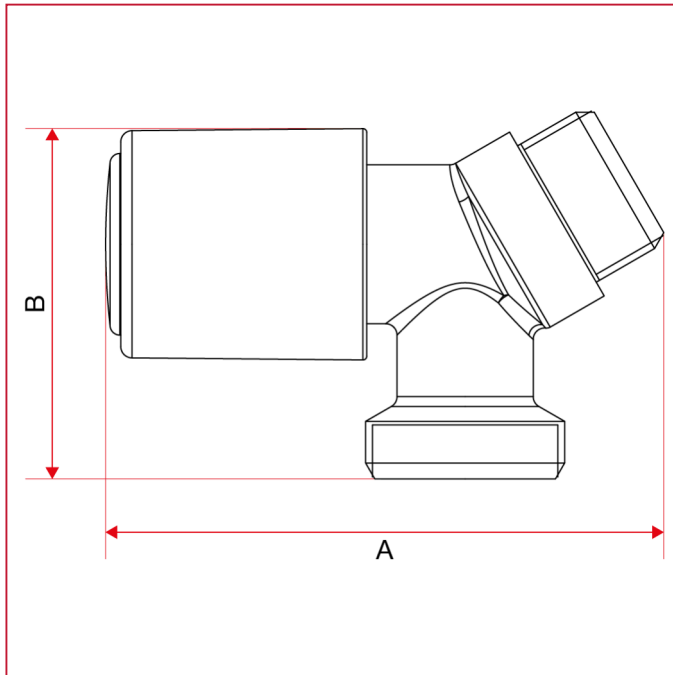

WASHING MACHINE VALVES

228 Inclined washing machine valve

OVERALL DIMENSIONS



	1/2"
DN	15
A	73,8
B	46,3
Kg/cm ² bar	16
LBS - psi	232