

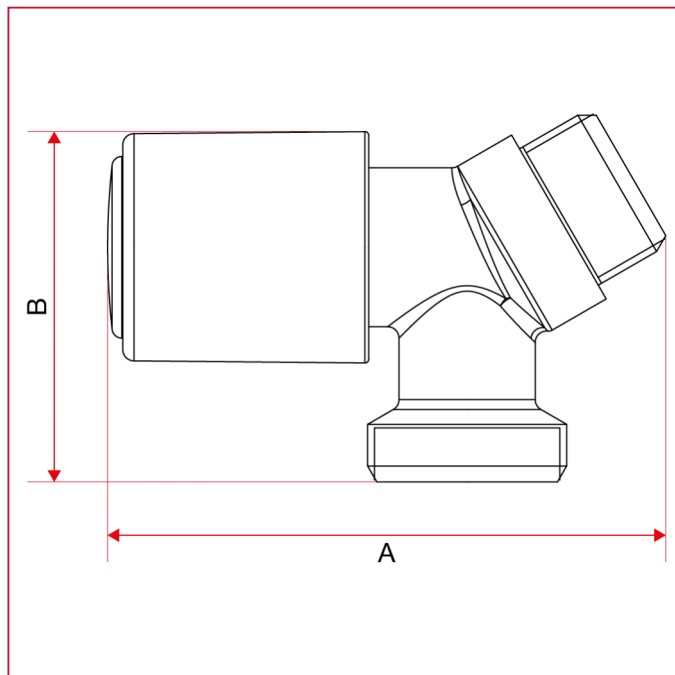

GRIFO CONEXIÓN LAVADORA

228 Grifo inclinado con conexión lavadora

Dimensiones totales



	1/2"
DN	15
A	73,8
B	46,3
Kg/cm2 bar	16
LBS - psi	232