

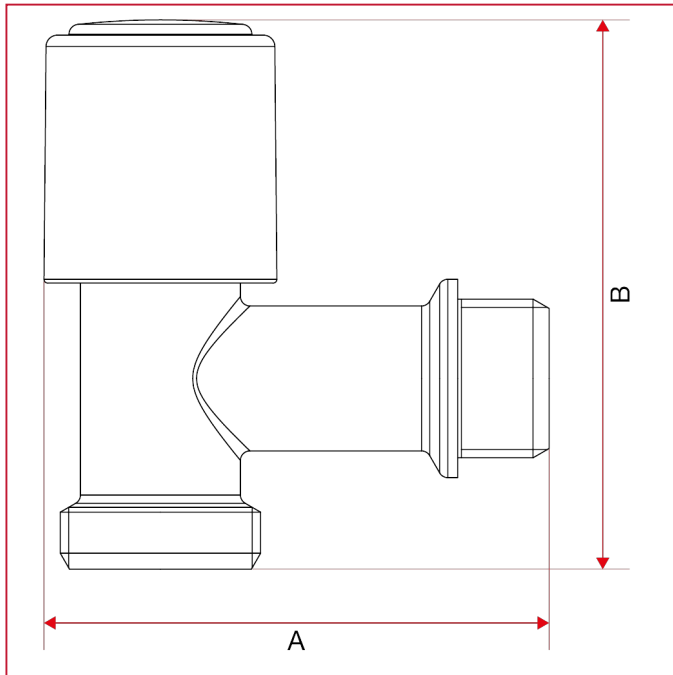

WASHING MACHINE VALVES

250 Washing machine valve

OVERALL DIMENSIONS



	1/2"
DN	15
A	66,3
B	72
Kg/cm ² bar	16
LBS - psi	232