

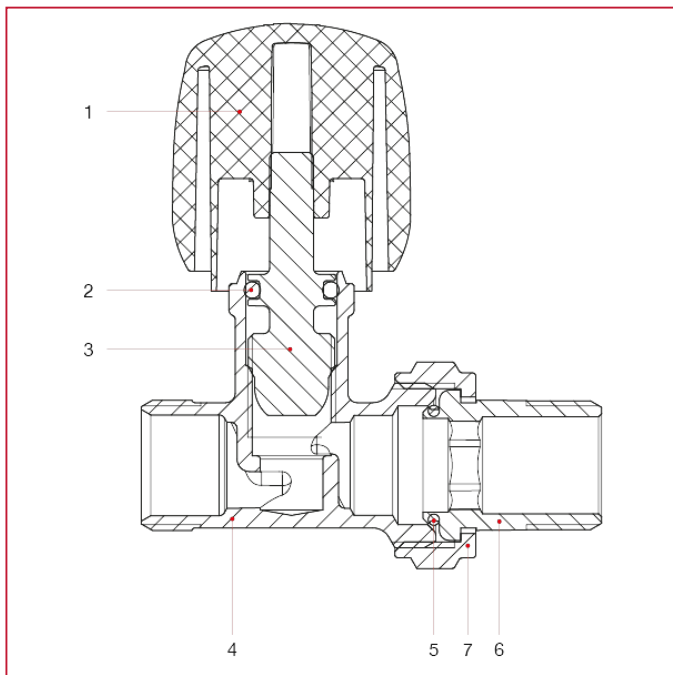

VALVOLE MANUALI E DETENTORI

295 Valvola diritta manuale

MATERIALI



POS.	DESCRIZIONE	N.	MATERIALE
1	Maniglia	1	ABS
2	Guarnizione	1	EPDM
3	Vitone	1	Ottone CW614N
4	Corpo	1	Ottone nichelato CW617N
5	Guarnizione	1	NBR
6	Codolo	1	Ottone nichelato CW617N
7	Dado	1	Ottone nichelato CW617N