

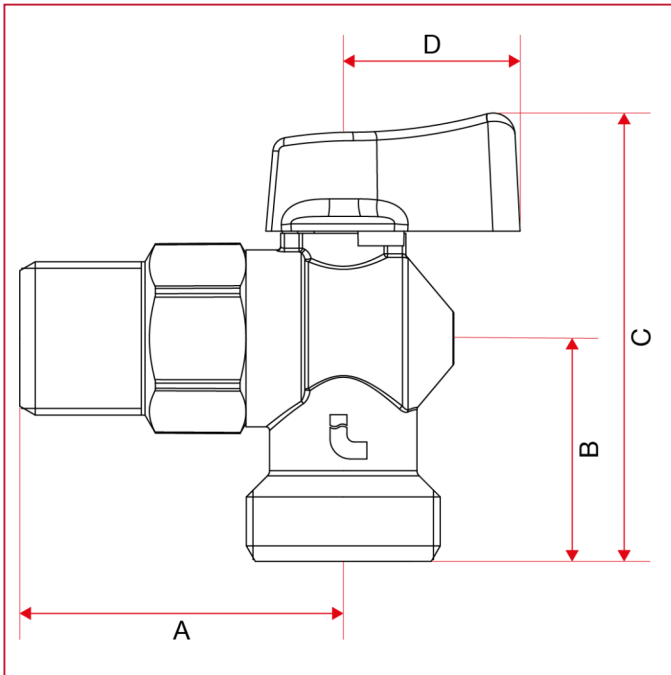

# WASHING MACHINE VALVES

## 392 Washing machine ball valve

### OVERALL DIMENSIONS



	1/2"
DN	15
A	44
B	30
C	61
D	24
Kg/cm <sup>2</sup> bar	16
LBS - psi	232