

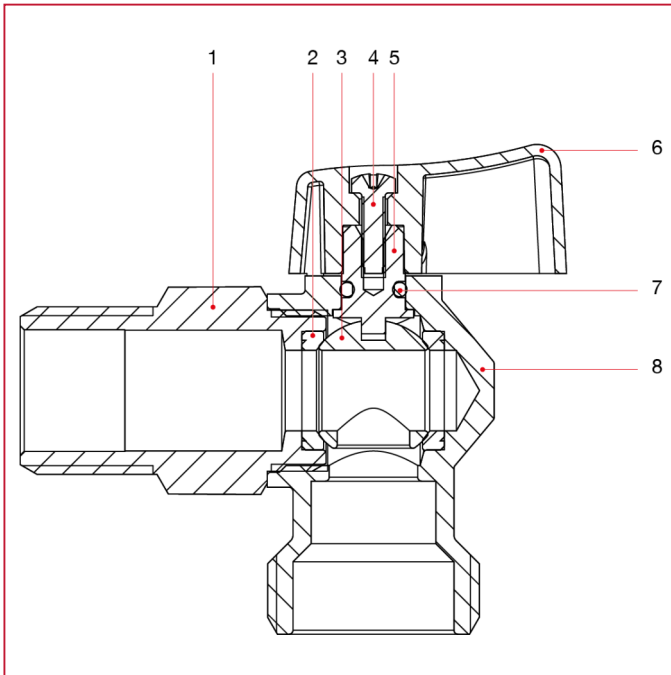

WASHING MACHINE VALVES

392 Washing machine ball valve

MATERIALS



POS.	DESCRIPTION	N.	MATERIAL
1	End adapter	1	Nickel-plated brass CW617N
2	Seat	2	P.T.F.E.
3	Ball	1	Chrome-plated brass CW614N
4	Screw	1	Zinc-plated steel C10C
5	Stem	1	Brass CW614N
6	Handle	1	Zamak
7	O-ring	1	NBR
8	Body	1	Nickel-plated brass CW617N