

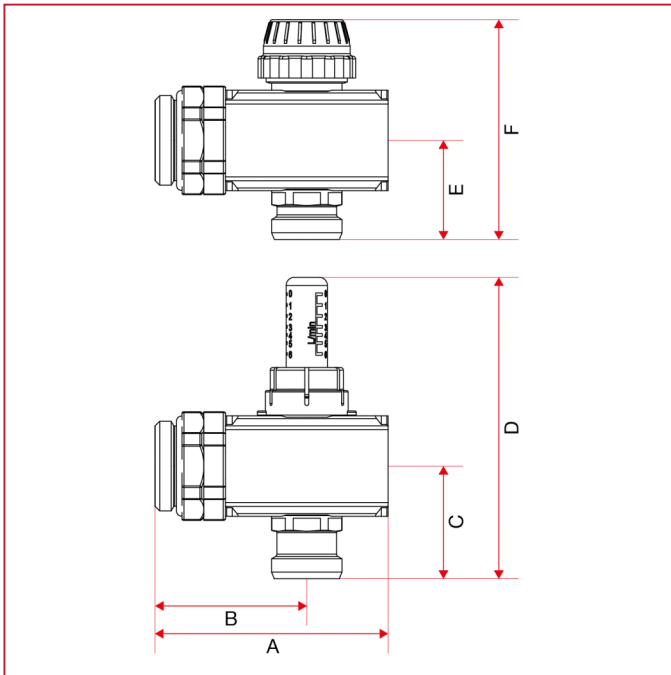

ACCESSORIES FOR MANIFOLDS

915CK Extension kit for manifolds

OVERALL DIMENSIONS



	1"X3/4"X 1"
A	86
B	56
C	41,5
D	111
E	36,5
F	81
Kg/cm ² bar	6
LBS - psi	87