

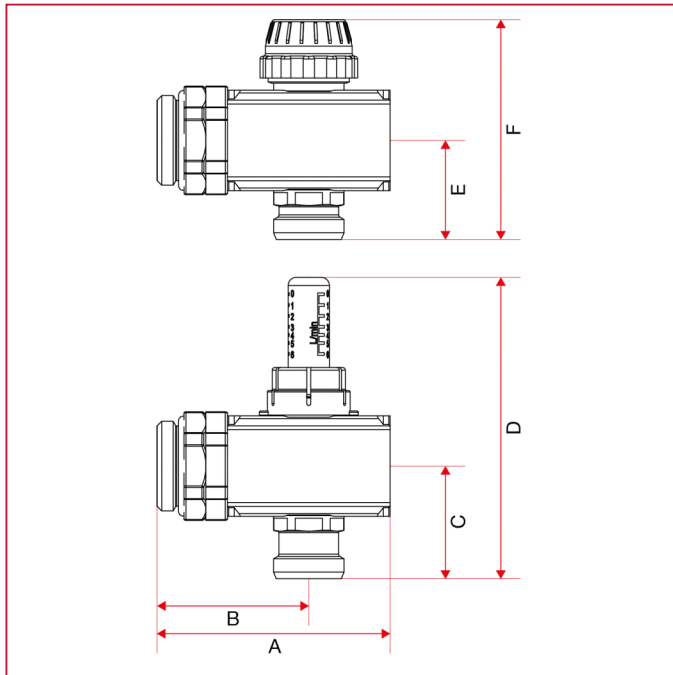

ACCESORIOS PARA COLECTORES

915CK Kit cable de extensión para colectores

Dimensiones totales



	1"X3/4"X 1"
A	86
B	56
C	41,5
D	111
E	36,5
F	81
Kg/cm2 bar	6
LBS - psi	87