

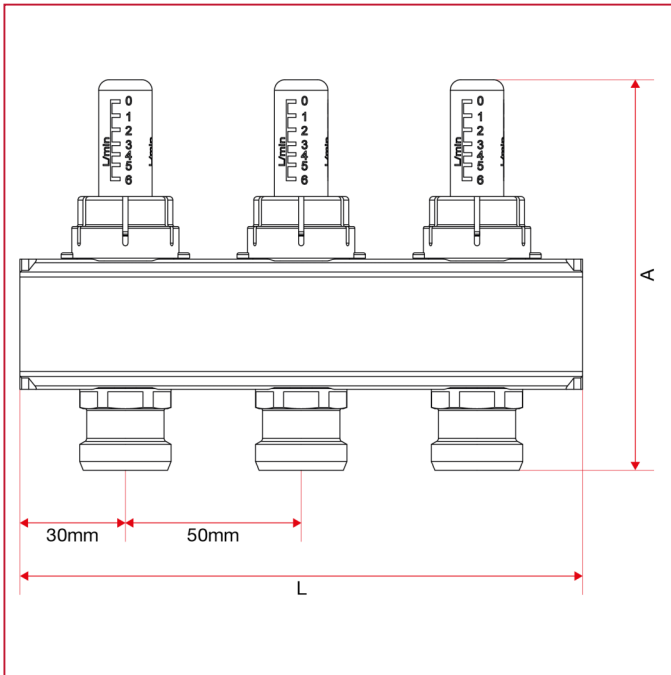

PRE-ASSEMBLED NICKEL-PLATED BRASS MANIFOLDS

930 Single manifold with flow meters

OVERALL DIMENSIONS



	1"x3/4"x 2	1"x3/4"x 3	1"x3/4"x 4	1"x3/4"x 5	1"x3/4"x 6	1"x3/4"x 7	1"x3/4"x 8	1"x3/4"x 9	1"x3/4"x 10	1"x3/4"x 11	1"x3/4"x 12	1"x3/4"x 13
A	111	111	111	111	111	111	111	111	111	111	111	111
L	110	160	210	260	310	360	410	460	510	560	610	660
Kg/cm ² bar	10	10	10	10	10	10	10	10	10	10	10	10
LBS - psi	145	145	145	145	145	145	145	145	145	145	145	145