

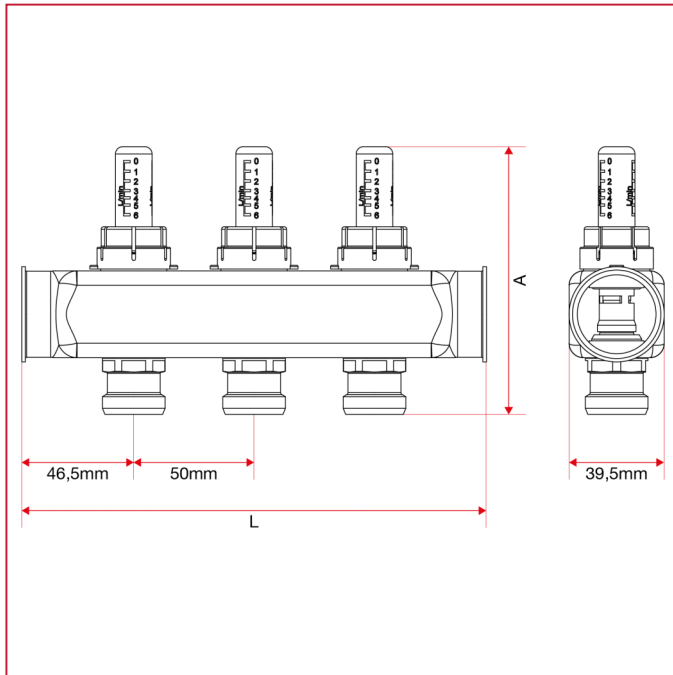

# PRE-ASSEMBLED STAINLESS STEEL MANIFOLDS

## 932 Single manifold with flow meters

### OVERALL DIMENSIONS



	1"x3/4"x 2	1"x3/4"x 3	1"x3/4"x 4	1"x3/4"x 5	1"x3/4"x 6	1"x3/4"x 7	1"x3/4"x 8	1"x3/4"x 9	1"x3/4"x 10	1"x3/4"x 11	1"x3/4"x 12	1"x3/4"x 13
A	111	111	111	111	111	111	111	111	111	111	111	111
L	143	193	243	293	343	393	443	493	543	593	643	693
Kg/cm <sup>2</sup> bar	6	6	6	6	6	6	6	6	6	6	6	6
LBS - psi	87	87	87	87	87	87	87	87	87	87	87	87